

S&G Audit Lock

Programming and Operations Guide

The Sargent & Greenleaf Audit Lock is designed to provide a high level of security combined with flexible features that allow multiple levels of control over normal operations. Follow these instructions carefully to get the best possible use from your lock.

INTRODUCTION

- The S&G Audit Lock is built using sophisticated electronic circuitry. These locks are suitable for indoor use only.
- The keypad should only be cleaned with a soft, dry cloth. Avoid solvents or liquids.
- Never attempt to lubricate the lock or keypad components. Service should only be performed by a qualified technician.
- Any time the keypad is removed from its mounting base, either disconnect the lock cable or support the keypad so that it does not hang by the cable. This could adversely affect the cable connector or the keypad receptacle.
- Each time a button is pressed and the lock accepts the input, it emits a "beep."
- All letters of the English alphabet are displayed on the keypad. This allows you to devise numeric, alphanumeric, or word-based codes. Use whatever approach works best for you.
- All codes end with #. This signals to the lock that you have finished entering all digits of the code.

Note: This lock has been Listed by Underwriters Laboratories for use with the following S&G keypad(s):
6120-0XX, 6120-2XX, 61KP-1XX, 61KP-2XX



Sargent & Greenleaf, Inc.
One Security Drive
Nicholasville, KY 40356
Phone: (800)-826-7652 Fax: (800)-634-4843
Phone: (859)-885-9411 Fax: (859)-887-2057

Copyright 2005, Sargent & Greenleaf

Sargent & Greenleaf S.A.
9, Chemin du Croset
1024 Ecublens, Switzerland
Phone: +41-21 694 34 00
Fax: +41-21 694 34 09

Document 630-711
Revised 5/16/2006



S&G Audit Lock ELECTRONIC LOCK

Programming and Operations Guide

1.	GENERAL INFORMATION	3
1.1	About Your Locking System	3
1.2	Factory Default Settings	4
2.	OPERATING THE LOCK	5
2.1	Operating Mode, PIN Positions, and User Codes	5
2.1.1	Operating Mode.	5
2.1.2	Setting the Operating Mode.	6
2.2	PIN Positions and Access Responsibilities	8
2.3	Beep Patterns.	10
2.3.1	Beep Pattern Table	10
2.4	Opening the Lock.	11
2.5	Keypad Input Errors and Clearing the Lock.	11
2.6	Penalty Time	12
2.7	Bolt Extension Indicator.	12
2.8	Keypad Tamper Indicator (optional feature).	12
2.9	Low Battery Indicator	13
2.10	Changing the Batteries.	13
2.11	iButton Touch Key	13
3.	PROGRAMMING THE LOCK.	14
3.1	Command 22: Changing a PIN Code	14
3.2	Command 28: Audit Download.	15
3.3	Command 43: Identifying the Type of Lock	16
3.4	Command 73: Set Date	16

- 3.5** Command 74: Add or Delete User Positions 17
 - Add a New User Position. 17
 - Delete a User 18
- 3.6** Command 74: Setting Up the Time Delay. 19
 - Time Delay Feature 19
 - Set Time Delay Duration 19
 - Changing the Opening Window Duration 20
- 3.7** Command 77: PIN Position Verification 21
- 3.8** Command 78: Set Time 22
- 3.9** Command 38: Setting the Duress Alarm Feature 22
 - Using the Duress Alarm Feature 23
 - Enable Duress Alarm Feature 23
 - Disabling the Duress Alarm Feature 23
 - Pin Code Position Verification Worksheet. 25

- Appendix A Specifications 26**
 - Warranty 26**

1.1 — About Your Locking System

The S&G Audit Lock Electronic Lock has the following hardware components:



Motorized Lock Body — Housed within the safe.



Keypad Extension — Installed under the keypad base. The extension provides a green LED to indicate “Status 1”, a red LED to indicate “Status 2”, and a yellow LED to indicate “Mode” of lock operation. The extension also provides a port for communication with Touch Keys.



Keypad and Base — The base is mounted above the keypad extension. The keypad is then snapped onto or seated on the base. The base is the black ring. This is a 12-key alphanumeric keypad used to enter PIN codes and programming commands.



Duress Module (optional) — Housed within the safe. This module must be connected to the lock to use the duress alarm feature.

Each time you press a number, letter, or other character on the keypad, it beeps and the keypad's red LED flashes. If there is no beep or LED flash, check the batteries and try again (See section 2.10 — ***Changing the Batteries***).

The # key acts as an enter function and must be used after each code entry.

The * key is used with Programming Command Codes. It may also be used to clear the keypad if there is an input error by entering the * key twice.

IMPORTANT: The lock responds with different beep sequences to indicate different conditions. The beeps are indicated in the examples by the symbol ♪. For example, five beeps are indicated by ♪♪♪♪♪. Always wait for each set of beeps to end before entering another number or letter, or you will interrupt the lock's instructions.

1.2 — Factory Default Settings

The S&G Audit Lock is shipped from Sargent & Greenleaf with factory default settings:

- Multiple User Mode - enabled
- Time Delay - zero minutes
- Duress - disabled

Positions 00, 02, and 10 have default PIN Codes set at the factory:

PIN Position Description	PIN Position	Default PIN Code
Programmer Code	00	123456
Manager Code	02	020202
User Code	10	101010

Programmer Code (PC) can only setup the operating parameters of the lock and download the audit trail data. **The Programmer Code cannot open the safe.**

This lock has the capacity for up to 30 PIN Code positions: 1 Programmer, 3 Managers, and 6 Supervisors who manage the lock programs and up to 20 Users who open and close the lock.

If the lock still has the original S&G factory default settings, you can open the lock by entering a PIN position and PIN Code, which makes up an 8-digit User code, followed by the # key.

To open the lock, use the factory setting for PIN position 10 with PIN Code 101010. Enter: 10101010 #.

(If lock does not open and beep patterns were heard after pressing the # key, see section 2.3.1 “Beep Patterns” to identify condition.)

We recommend that Users change their PIN Codes immediately after the PIN positions are assigned (Section 3.1).

2.1 — Operating Mode, PIN Positions, and User Codes

2.1.1 — Operating Mode

The S&G Audit Lock has an access hierarchy of Managers (PIN positions 01, 02, and 03), Supervisors (PIN positions 04 through 09), and Users (PIN positions 10 through 29). See Tables A&B for access privileges.

The lock can be configured to operate in three different User access modes:

- **Multiple User mode** — any valid code (Supervisor, Manager, or User) can open the lock.
- **Manager/Employee mode** — the Managers or Supervisors enable/disable the access privilege of individual User Codes. Manager and Supervisor Codes do not open the lock in this mode.
- **Dual Control mode** — two independent User Codes are needed to open the lock. Manager and Supervisor Codes can be used to open the lock in this mode.

2.1.2 — Command 32: Setting the Operating Mode

Enable Manager/Employee Mode

Enable the lock for Manager/Employee mode by performing the following steps:

- Step 1.** Enter: **3 2 ***
- Step 2.** Enter: 2-digit Programmer or Manager PIN position (00-03)
6-digit PIN Code for the PIN position entered

♪♪♪♪♪♪
- Step 3.** Enter: **2** (Function Number)

♪♪♪
- Step 4.** Enter: **2** (Function Number)

♪♪♪

The lock now requires input of a Management code to enable the User codes.

Enable Dual Control Mode

Set the lock for Dual Control mode operation by performing the following steps:

- Step 1.** Enter: **3 2 ***
- Step 2.** Enter: 2-digit Programmer or Manager PIN position (00-03)
6-digit PIN Code for the PIN position entered

♪♪♪♪♪♪
- Step 3.** Enter: **3** (Function Number)

♪♪♪
- Step 4.** Enter: **3** (Function Number)

♪♪♪

The lock is now set in Dual Control mode, requiring two valid User or Management codes to gain access.

2.1.2 — Command 32: Setting the Access Mode (cont.)

Enable Multiple User Mode

Enable the lock for Multiple User mode by performing the following steps:

Step 1. Enter: **3 2 ***

Step 2. Enter: 2-digit Programmer or Manager PIN position (00-03)
6-digit PIN Code for the PIN position entered

♪♪♪♪♪♪

Step 3. Enter: **4** (Function Number)

♪♪♪

Step 4. Enter: **4** (Function Number)

♪♪♪

The lock is now set to Multiple User mode and can be opened using any valid code.

2.2 — PIN Positions and Access Responsibilities

This section defines each PIN position and the respective User functions as summarized in Tables A&B.

PIN position 00, the Programmer position, can only configure the lock and download the audit trail. The Programmer cannot open any locks.

Each User is assigned a 2-digit PIN (Personal Identification Number) position and a 6-digit PIN Code. The PIN position identifies the type of User (Programmer, User, etc.) The PIN Code allows the User to access the lock. Together these two codes form the 8-digit User Code. Each User can change their own PIN Code but not PIN position.

Users will always enter both their PIN position and PIN Code, followed by the # key.

PIN POSITION *PIN CODE*
 Example: 02 020202 #

Table A: Programmer Code

Pin Position	Position Description	Activity
00	Programmer Code	<ul style="list-style-type: none"> • Cannot open lock.
		<ul style="list-style-type: none"> • Cannot add/delete other PIN Codes.
		<ul style="list-style-type: none"> • Can change its own PIN code.
		<ul style="list-style-type: none"> • Send duress alarm (when programmed).
		<ul style="list-style-type: none"> • Can program the lock's functions (audit downloads, time delay, set time, duress, and date).

Table B: User Groups

PIN Position	Position Description	Access
01 - 03	Managers	<ul style="list-style-type: none"> • Open the lock.
		<ul style="list-style-type: none"> • Add new Users.
		<ul style="list-style-type: none"> • Delete Users.
		<ul style="list-style-type: none"> • Start time delay (when programmed).
		<ul style="list-style-type: none"> • Send duress alarm (when programmed).
		<ul style="list-style-type: none"> • Change their own PIN Code.
04 - 09	Supervisors	<ul style="list-style-type: none"> • Open the lock.
		<ul style="list-style-type: none"> • Delete Users.
		<ul style="list-style-type: none"> • Start time delay (when programmed).
		<ul style="list-style-type: none"> • Send duress alarm (when programmed).
		<ul style="list-style-type: none"> • Change their own PIN Code.
10 - 29	Users	<ul style="list-style-type: none"> • Open the lock.
		<ul style="list-style-type: none"> • Start time delay (when programmed).
		<ul style="list-style-type: none"> • Send duress alarm (when programmed).
		<ul style="list-style-type: none"> • Change their own PIN Code.

2.3 — Beep Patterns

The following table lists the beep patterns heard when using the S&G Audit Lock (KEB = Keypad Extension Base).

2.3.1 — Beep Patterns (beep¹ is the sound emitted when any single button is pressed; beep² is pitched lower; brap is a louder sound emitted when an error occurs on the lock)

Action/Condition	Tone & Keypad LED	KEB LED (if present)	Duration
Normal Condition	-	-	-
Each Keystroke	1 beep ¹	-	1 cycle
Low Battery	2 beep ¹	Red	5 cycles
Battery Too Low	20 beep ¹	Red	1 cycle
Tamper Indication	3 beep ¹ +3 beep ² +3 beep ¹	Red	2 cycles
Start Time Delay	3 quick beep ¹	Red	1 cycle
Time Delay Countdown	1 beep ¹	Red	Every 10 sec.
Time Delay Expired	10 quick beep ¹	Green	1 cycle
Open Window Countdown	2 beep ¹	Green	Every 6 sec.
Bolt Extension	1 beep ² + 1 beep ¹	Red	1 cycle
Code Input - Lock in Penalty Time	2 brap	Red	1 cycle
Code Input - Lock Disabled	2 beep ²	Red	1 cycle
Lock ID*	4/5 beep ¹ + 2 beep ² + 4 beep ¹	Green	1 cycle
Enable Lock (mgr/emp mode)	4 beep ¹	Green	1 cycle
Disable Lock (mgr/emp mode)	2 beep ²	Red	1 cycle
Access to Program Modes	5 beep ¹	Green	1 cycle
Program Argument Confirmation	3 beep ¹	Green	1 cycle
Program Complete	3 beep ¹	Green	1 cycle
Mode 77 - PIN used	1 beep ²	Red	1 cycle
Mode 77 - PIN empty	1 brap	Red	1 cycle
Wrong Input/Access Denied	1 brap	Red	1 cycle

* 4 beeps indicates a standard S&G Audit Lock

5 beeps indicates a push/pull lock S&G Audit Lock

2.4 — Opening the Lock

Time Delay —The lock may be programmed with a time delay from 0 - 99 minutes with an opening window of 1 - 10 minutes.

If your lock does not use the time delay

Enter: Your 2-digit PIN position
 Your 6-digit PIN Code
 #
 Turn the safe handle to the unlocked position within 6 seconds.

If your lock uses the time delay

Enter: Your 2-digit PIN position
 Your 6-digit PIN Code
 #

The pre-set time delay period begins after you enter your code. During this period, the lock beeps once every 10 seconds. At the end of the time delay, the lock will beep rapidly 10 times to signal the start of the opening window, the period during which you can open the lock.

During the opening window, the lock beeps twice every 6 seconds. You must now:

Enter: Your 2-digit PIN again
 Your 6-digit User Code again
 #
 Turn the safe handle to the unlocked position within 6 seconds.

2.5.— Keypad Input Errors and Clearing the Lock

If you make a mistake while entering a User Code, press * twice at any time to clear the lock and start over. If you hear a single long beep after entering the # key, you have made an error. Press * key twice to clear and try again, or you can wait 10 seconds and the lock will clear itself.

CAUTION: During normal entry, don't wait more than 10 seconds between entries or the lock will clear and you will have to start over.

2.6 — Penalty Time

If you enter 5 incorrect codes in a row, the lock goes into a 10-minute penalty time and cannot be opened. Once in penalty time, additional input does not affect the lock, and you must wait 10 minutes before any valid code entry will be accepted.

2.7 — Bolt Extension Indicator

When the lock bolt extends to the locked position, you will hear one double beep (low then high pitch).

2.8 — Keypad Tamper Indicator (optional)

The lock records each time the keypad housing is unseated or removed from the base. If the housing is disturbed, the keypad tamper indicator beeps an SOS warning (3 short/high pitch beeps; 3 short/low pitch beeps; 3 short/high pitch beeps) the next time you enter a valid access code.

The lock will not open at this point. The SOS signal will repeat twice. When it stops beeping, enter a valid code within one minute to reset the keypad tamper indicator and open the lock.

The keypad will not work when disconnected from the base. If the lock is in Manager/Employee mode, it may have to be re-enabled by a Manager or Supervisor code.

2.9 — Low Battery Indicator

If you enter a correct User Code and hear 5 double beeps when the lock opens, the batteries are low. Change the batteries.

If the batteries are so low the lock can't work properly, the lock beeps 20 times when a User code is entered and will not open. Change the batteries right away and re-enter a User code to open the lock.

The 9V batteries are located behind the keypad.

2.10 — Changing the Batteries

The lock will not lose any codes or program settings when you replace the batteries.

The lock uses two 9-volt alkaline batteries. We recommend Duracell® alkaline batteries.

To change the batteries, carefully remove the keypad housing by lifting the bottom edge (closest to the S&G logo) and easing it off the base. Detach the old batteries from the terminals. Insert the new batteries, supporting the top of each battery holder with your other hand to prevent bending or breaking the holder.

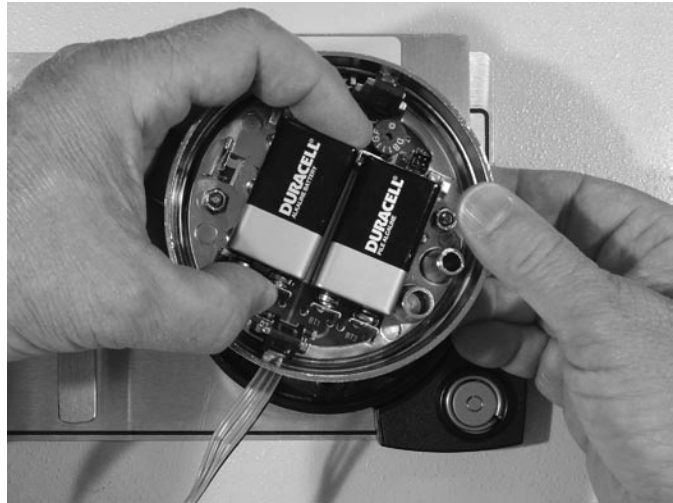

2.11 — iButton Touch Key

The touch key allows you to transfer the audit trail from the lock to your computer. The audit trail is a time and date stamped record of all lock activity.

For more instructions on downloading the audit trail, see Section 3.2.



These programming commands allow you to perform a variety of lock functions.

Command	Description/Function
2 2 *	Change PIN Code.
2 8 *	Download the Audit Trail.
3 2 *	Set Mode of Operation.
3 8 *	Enable/Disable Duress—Duress Module required.
4 3 *	Identify the type of lock.
7 3 *	Set date.
7 4 *	Add or delete User PIN Codes & Set Time Delay.
7 7 *	Verify PIN position.
7 8 *	Set time.

3.1 — Command 22: Changing a PIN Code

Use Command 22 to change your own PIN Code. Always leave the safe door open while changing codes. When changing a User Code, you will enter both the 2-digit PIN position and the 6-digit PIN Code. The PIN position does not change.

To change a PIN Code, perform the following steps (A PIN Code can contain any numbers/letters except # or *):

- Step 1.** Enter: **2 2 ***
- Step 2.** Enter: 2-digit PIN position
Current 6-digit PIN Code

♪♪♪♪♪♪
- Step 3.** Enter: 2-digit PIN position
New 6-digit PIN Code

♪♪♪
- Step 4.** Enter: 2-digit PIN position again
New 6-digit PIN Code again

♪♪♪

Try the new PIN Code at least three times to confirm operation before closing the safe door.

3.2 — Command 28: Audit Download

The S&G Audit Lock Audit Trail can store as many as 400 time and date events. Some examples of events are:

- Adding or deleting a User code.
- Changing a code.
- Opening or closing the lock.
- Programming commands, such as setting the date.

The audit trail can be downloaded to a Touch Memory key and uploaded to a computer using the Sargent and Greenleaf Audit Lock Audit Trail Software. Complete instructions are provided with the software.

To download the Audit Trail, perform the following steps:

Step 1. Enter: **2 8 ***

Step 2. Enter: 2-digit Programmer PIN position (OO)
6-digit PIN Code
#

Step 3. Press the silver face of the Touch Memory Key into the corresponding port (the round depression) on the keypad extension. The touch key will snap into place and will be retained.

The yellow LED will remain on while the audit trail is downloading to the Touch Memory Key. This takes about 20 seconds.

The lock will beep 5 times ♪ ♪ ♪ ♪ ♪ when the download is complete.

If you hear a brap (one long, continuous beep), the audit trail was not downloaded properly. You must restart the download, beginning with Step 1.

After you've successfully downloaded the audit trail, it is stored in the Touch Key. Follow the instructions provided with the Sargent and Greenleaf audit trail software to upload the data to your computer.



3.3 — Command 43: Identifying the Type of Lock

At times, a service technician may need to know what type of lock is mounted on the safe door.

To identify the lock, perform the following steps:

- Step 1.** Enter: **4 3 ***
- Step 2.** Listen for the three sets of beeps. Use the table below to determine the type of lock.

Beep Set	Number of Beeps	
1st set (high pitch)	4	5
2nd set (low pitch)	2	2
3rd set (high pitch)	4	4
Type of Lock	Standard S&G Audit Lock	Push/Pull Bolt Lock

3.4 — Command 73: Set Date

You must set the date in order to use the audit trail function. The date should be entered in DDMMYY format, where DD = day, MM = month, and YY = year. The date should be set when the lock is first set up and prepared for use. To set the date, perform the following steps:

- Step 1.** Enter: **7 3 ***
- Step 2.** Enter: 2-digit Programmer PIN position (00)
6-digit PIN Code

♪♪♪♪♪♪
- Step 3.** Enter: 2-digit Manager or Supervisor PIN position (01-09)
6-digit PIN Code





♪♪♪♪♪♪
- Step 4.** Enter: Date in DDMMYY format

♪♪♪♪
- Step 5.** Enter: Confirm date by entering it again in DDMMYY format

♪♪♪♪

Example



To set the date as July 4, 2018 (using the factory default Codes):

- Step 1.** Enter: **7 3 ***
- Step 2.** Enter: **0 0**
1 2 3 4 5 6 #

- Step 3.** Enter: **0 2**
0 2 0 2 0 2 #

- Step 4.** Enter: **0 4 0 7 1 8 #**

- Step 5.** Enter: **0 4 0 7 1 8 #**

3.5 — Command 74: Add or Delete Code Positions

Add a New User Position



To add or delete User positions, perform the following steps:

- Step 1.** Enter: **7 4 ***
- Step 2.** Enter: 2-digit Manager PIN position (01, 02, or 03)
 6-digit PIN Code
#

- Step 3.** Enter: New 2-digit PIN position
 A 6-digit PIN Code
#

- Step 4.** Enter: New PIN position again to confirm
 6-digit PIN Code again to confirm
#

After a User has been assigned a PIN position and a PIN Code, we recommend that each User change his or her PIN Code using Command 22.

Example



Add PIN position 14 (using the factory default Codes). Note that for new Users, you can assign any PIN Code as long as it does not contain * or # as one of the digits.

- Step 1.** Enter: **7 4 ***
- Step 2.** Enter: **0 2**
0 2 0 2 0 2 #

- Step 3.** Enter: **1 4**
1 4 1 4 1 4 #

- Step 4.** Enter: **1 4**
1 4 1 4 1 4 #

The User should now change their PIN Code using Command 22.



Delete a User

To delete a User, you only need to know their 2-digit PIN position and perform the following steps.

- Step 1.** Enter: **7 4 ***
- Step 2.** Enter: 2-digit Manager or Supervisor PIN position.
 6-digit PIN Code
#

- Step 3.** Enter: 2-digit PIN position to be deleted
#

- Step 4.** Enter: 2-digit PIN position again to confirm
#

Example

Delete the User for PIN 14.

- Step 1.** Enter: **7 4 ***
- Step 2.** Enter: **0 2**
0 2 0 2 0 2 #

- Step 3.** Enter: **1 4 #**

- Step 4.** Enter: **1 4 #**

3.6 — Command 74: Setting Up the Time Delay

Time Delay Feature

The S&G Audit Lock can be programmed with a time delay feature. Time delay applies only to those users who can open the lock.

The time delay can be set from 0 to 99 minutes. The red LED light on the keypad flashes with a single beep every 10 seconds as a reminder that the lock is in the time delay period. When the time delay expires, the lock emits 10 rapid beeps to indicate that it can now be opened. During this opening window, the lock beeps and the LED flashes twice every 6 seconds.

The opening window factory default is set for 2 minutes, but the opening window can be set from 1 to 10 minutes.

To open the lock, a User must enter their User Code to start the time delay period, wait the length of the time delay period, and then enter a valid User Code during the opening window. If the lock is not opened during the open window period, it automatically resets and the process must be repeated.

The S&G Audit Lock comes from the factory with no time delay set.

NOTES:

1. If the time delay has already been set, changes to both the opening window and time delay duration can only be made during the opening window.
2. Use Command 74* to set both the time delay and the opening window. Enter the respective function number 00 or 01 for the desired setting.

IMPORTANT: Do not set the time delay until you have finished all other programming functions or you will have to wait through the time delay before making any other programming changes.

Set time delay duration

If the time delay has already been set, enter a User Code to start the delay. When the time delay expires (the lock emits 10 rapid beeps) and the opening window has begun, immediately proceed to change the time delay by performing the following steps:

- Step 1.** Enter: **7 4 ***
- Step 2.** Enter: 2-digit Programmer PIN position (00)
6-digit PIN Code

- Step 3.** Enter: **00** (Function Number)





- Step 4.** Enter: Time delay minutes (0-99)

- Step 5.** Enter: Time delay minutes again (0-99)



Example





To set the time delay to 10 minutes:

- Step 1.** Enter: **7 4 ***
- Step 2.** Enter: **0 0** (PC 2 digit position)
1 2 3 4 5 6 # (PC 6 digit Code)

- Step 3.** Enter: **0 0 #** (Function Number)

- Step 4.** Enter: **1 0 #** (Number of Minutes Time Delay)

- Step 5.** Enter: **1 0 #** (Number of Minutes Time Delay)

To eliminate the time delay period, simply enter zero (0) for the time delay minutes.

Changing the opening window duration

If the time delay has already been set, enter a User Code to start the delay. When the time delay expires (the lock emits 10 rapid beeps) and the opening window has begun, immediately proceed to set the opening window minutes by performing the following steps:

- Step 1.** Enter: **7 4 ***
- Step 2.** Enter: 2-digit Programmer PIN position (00)
 6-digit PIN Code
 #

- Step 3.** Enter: **0 1** (Function Number)
 #

- Step 4.** Enter: Opening window minutes (1-10)
 #

- Step 5.** Enter: Opening window minutes again (1-10)
 #

Example

To set the opening window to 5 minutes:

- Step 1.** Enter: **74***
- Step 2.** Enter: **00** (PC 2 digit pin position)
1 2 3 4 5 6 # (PC 6 digit pin Code)
 ♪♪♪♪♪
- Step 3.** Enter: **01 #** (Function Number)
 ♪♪♪
- Step 4.** Enter: **5 #** (Number of Minutes for Opening Window)
 ♪♪♪
- Step 5.** Enter: **5 #** (Number of Minutes for Opening Window)
 ♪♪♪

If time delay has not been previously set, the setting of time delay may begin immediately upon input of the correct code sequence.

3.7 — Command 77: PIN Position Verification

Use this code to verify that a User has been assigned to a PIN position. For example, it will tell you whether PIN 07 has a PIN Code in this position. In order to manage the PIN User Codes, the **PIN Code Position Verification Worksheet** is recommended.

- Step 1.** Enter: **77***
- Step 2.** Enter: PIN position to be verified and #

One long beep means no Code is set for that position. One short beep means a Code is set.

3.8 — Command 78: Set Time

You must set the time in order to use the audit trail function. The time should be in HHmm format based on a 24-hour clock, where HH = hours and mm = minutes. The time should be set when the lock is first installed. The time is to always be set in local standard time. Local standard time must be set, even though daylight savings time may be in effect. To set the time, perform the following steps:

- Step 1.** Enter: **7 8 ***
- Step 2.** Enter: 2-digit Programmer PIN position (00)
6-digit PIN Code

♪♪♪♪♪♪
- Step 3.** Enter: 2-digit Manager or Supervisor PIN position
(01-09 PIN positions only)
6-digit PIN Code

♪♪♪♪♪♪
- Step 4.** Enter: Time in HHmm format

♪♪♪
- Step 5.** Enter: Time in HHmm format again to confirm

♪♪♪

Example

To set the time as 3:15 p.m., becoming 15:15 in 24-hr format (using the factory default Codes):

- Step 1.** Enter: **7 8 ***
- Step 2.** Enter: **0 0**
1 2 3 4 5 6 #
♪♪♪♪♪♪
- Step 3.** Enter: **0 2**
0 2 0 2 0 2 #
♪♪♪♪♪♪
- Step 4.** Enter: **1 5 1 5 #**
♪♪♪
- Step 5.** Enter: **1 5 1 5 #**
♪♪♪

3.9 — Command 38: Setting the Duress Alarm Feature

The model 6128/6129 lock has an optional duress, or silent alarm, option. The optional duress module must be connected to the lock and your alarm system for this feature to work.

Using the Duress Alarm Feature

To send a duress alarm to the alarm center, enter a User Code that is one number higher or lower than the last number of a User's normal PIN Code and press the # key.

For example, if the normal User Code is 123456 for PIN position O2, the User can activate the duress alarm by entering O2123455 or O2123457, followed by #. If the User Code ends in 0, use 1 or 9 to activate the duress alarm. The lock will operate normally when a Duress code is entered.

All User Codes can send the duress signal at any time. It can also be sent during programming sequences.

Enable Duress Alarm Feature

After the lock is installed with the module, the duress feature must be enabled by performing the following steps:

- Step 1.** Enter: **3 8 ***
- Step 2.** Enter: 2-digit Programmer or Manager PIN position (OO - O3)
6-digit PIN Code

- Step 3.** Enter: 1 (Function Number)

- Step 4.** Enter: 1 (Function Number)



The lock can now send a duress signal through the interface module.

Disabling the Duress Alarm Feature

The duress feature can be disabled without disconnecting the duress module by performing the following steps:

- Step 1.** Enter: **3 8 ***
- Step 2.** Enter: 2-digit Programmer or Manager PIN position (OO - O3)
6-digit PIN Code



(continued on next page)

Step 3. Enter: 0 (Function Number)

♪♪♪

Step 4. Enter: 0 (Function Number)

♪♪♪

PIN CODE POSITION VERIFICATION WORKSHEET

Position	Description	Code Set? Yes or No
00	Programmer	
01	Manager	
02	Manager	
03	Manager	
04	Supervisor	
05	Supervisor	
06	Supervisor	
07	Supervisor	
08	Supervisor	
09	Supervisor	
10	User	
11	User	
12	User	
13	User	
14	User	
15	User	
16	User	
17	User	
18	User	
19	User	
20	User	
21	User	
22	User	
23	User	
24	User	
25	User	
26	User	
27	User	
28	User	
29	User	

Appendix A. Specifications

Below are the specifications for the S&G Audit Lock electronic safe locks and 61KP keypads.

Lock dimensions

- Width: 2.4 inches (62 mm)
- Height: 1.1 inches (30 mm)
- Length: 3.32 inches (84 mm)

Keypad dimensions

- Diameter: 4 inches (101 mm)
- Height: 1.44 inches (36 mm)

Weight

- 1 pound (450 g)
- Housing/base: 0.7 pound (320 g)
- Module: 1 pound (450g)

Shipping weight

- 2.75 pounds (1250 g)

Finish

- Case: Black paint
- Cover: Black paint
- Keypad: Satin chrome plated (standard)

Power

- Two 9-volt alkaline batteries in keypad (Duracell® recommended)

Battery life

- Approximately 5000 openings (based on use of Duracell® alkaline batteries)
Note: Use of time delay will decrease battery life.

Low battery detection

- Beep/LED flash feedback from keypad (5 double beeps/flashes)

Operating temperature

- 32° to 120° F (0° to 50° C)
Keep batteries fresh when operating at lower temperatures

WARRANTY S&G Audit Lock Electronic Safe Lock

Limited Warranty

Seller warrants that for two (2) years from the date of shipment from Seller's point of manufacture, the goods will be free from defects in material and workmanship, provided the goods are normally and properly used according to the Seller's written instructions.

THIS WARRANTY IS EXPRESSLY MADE IN LIEU OF ANY AND ALL OTHER WARRANTIES, EXPRESS OR IMPLIED. S&G DOES NOT WARRANT THAT THE GOODS ARE MERCHANTABILITY OR FIT FOR ANY PARTICULAR PURPOSE EXCEPT AS EXPRESSLY PROVIDED HEREIN.

Seller's entire liability and Buyer's exclusive remedy in the event that the goods do not conform to the foregoing warranty shall be Seller's repair or replacement of the goods (including payment of freight costs to and from point of manufacture). This warranty does not apply to batteries or damage from battery leakage.

SELLER SHALL HAVE NO LIABILITY FOR ANY CONSEQUENTIAL, INCIDENTAL, INDIRECT OR SPECIAL DAMAGES. SELLER DOES NOT WARRANT ITS LOCK PRODUCTS TO BE IMPERVIOUS TO FORCIBLE OR SURREPTITIOUS ENTRY, AND SELLER SHALL HAVE NO LIABILITY FOR DAMAGE TO OR LOSS OF PROPERTY SOUGHT TO BE PROTECTED BY ANY SUCH LOCK.

S&G Confidential

The information contained in this document is proprietary to Sargent & Greenleaf, Inc. Publication or duplication of this copyrighted document is strictly prohibited.

Sargent & Greenleaf, Inc.
One Security Drive
Nicholasville, KY 40356
Phone: (800)-826-7652 Fax: (800)-634-4843
Phone: (859)-885-9411 Fax: (859)-887-2057

Sargent & Greenleaf S.A.
9, Chemin du Croset
1024 Ecublens, Switzerland
Phone: +41-21 694 34 00
Fax: +41-21 694 34 09

